



ECHOGRAPH 1095

Digital Ultrasonic Flaw Detector

Models
1095 BASIC
1095 DAC/TCG/AWS
1095 DGS/DAC/TCG
1095 DGS/DAC/TCG/AWS/JIS

KARL DEUTSCH

ECHOGRAPH 1095 – The New Generation of Manual Ultrasonic Testing



The convenient transport case provides space for extensive accessories

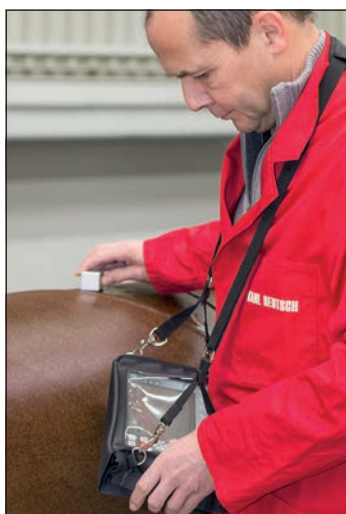

Mobile ultrasonic inspection with the ECHOGRAPH 1095 in the practical carrying case

ECHOGRAPH 1095 – High-tech meets comfort: Ultrasonic Testing made simple

Besides the proven qualities of its predecessor model the new ultrasonic flaw detector ECHOGRAPH 1095 features time corrected gain and backwall echo attenuation. It is the ideal instrument for manual ultrasonic testing: digital, high-contrast and comfortable in practical applications. It is reliable and sturdy and thus can be used outdoors or in rough industry environment.

The ECHOGRAPH 1095 ...

- is lightweight (only 2 kg) and easy to handle
- is equipped with a very large and high-contrast TFT colour display (7" diagonal, resolution 800 x 480 pix) with automatic brightness control and a large viewing angle
- guides the user safely and self-explanatorily through the applications by means of its plain text menu
- ensures extremely simple and complete adjustment with its user guidance
- supports the operator during probe handling and instrument adjustment (DGS, DAC, TCG, AWS, JIS, ...)
- offers direct access to all important key functions
- displays up to 6 measured values in large digits
- is equipped with 3 monitors to measure amplitude and time-of-flight, as well as 3 associated control lamps on the front panel for monitoring threshold values
- enables to show reference echoes and to record echo dynamics
- enables simple freezing and storing of A-scans
- allows to move all 3 monitor gates in "freeze" mode or in a stored data set and recalculates the displayed measured values accordingly
- comes with a convenient text editor which enables the storage of each data set with an individual file name
- contains a probe data base for easy entering of probe data, even for third-party probes
- displays all functions in plain text on the screen, in addition to the 6 function keys
- permits selection of the pulse repetition frequency (PRF) from 10 Hz up to 5000 Hz: low PRF to avoid ghost echoes, and high PRF for high testing speed in case of automated testing
- saves all data, e.g. screenshots as BMP files or series of measurements as CSV files, on a removable 8 GB industrial SD flash card
- evaluates the time-of-flight between transmitter pulse and an echo within the monitor gate
- measures the wall thickness between transmitter pulse – backwall or backwall – backwall, either between echo peaks, edges or zero crossings
- provides 0.01 mm indication accuracy in the evaluation mode wall thickness measurement with zero crossing triggering
- allows evaluation also on curved surfaces (e. g. pipes)
- provides a VGA output for external monitors
- is delivered with a colour rubber protective holster to avoid sliding and for additional protection
- offers a separate adjustable gain in the third monitor, e. g. for individual backwall echo attenuation
- has an adjustable square pulser with a pulse width automatically adapted to the frequency of the probe when it is loaded, but which can be changed manually as well
- features digital filters for optimal adaption to the probe
- is dust-proof and provides protection against water jets according to IP65

The ECHOGRAPH 1095 available in 4 versions:

- 1095 Basic
- 1095 DAC/TCG/AWS
- 1095 DGS/DAC/TCG
- 1095 DGS/DAC/TCG/AWS/JIS

Options:

- Matrix memory
- TOFD
- B-scan
- Strip chart
- Interface module for external control

Packages and scope of supply

	order nos.
ECHOGRAPH 1095 Basic	1095.020
ECHOGRAPH 1095 DAC/TCG/AWS	1095.030
ECHOGRAPH 1095 DGS/DAC/TCG	1095.040
ECHOGRAPH 1095 DGS/DAC/TCG/AWS/JIS	1095.050
<i>included in delivery:</i>	
<i>instrument with red protective holster, Li-ion rechargeable battery, mains/charging device and transport case</i>	
Accessories for the standard package:	
Carrying case incl. belt	6189.101
Interface box IFB to connect a PLC	
Standard / Hi Speed	1877.201 / 1877.202
USB cable	1657.704
eCom 95, PC software for	
Windows XP/7/8/10 Desktop	1995.007
Spare battery pack 7.4 V; 7.6 Ah	1808.551
Charger unit for external charging of a spare battery	1808.531

Matrix Memory

TOFD (Time-of-Flight Diffraction)



Matrix Memory

Measured values can be stored to cells of a matrix grid. If the matrix grid is assigned to measurement locations of the part to be tested, assessment of the results is much easier due to the visual impression of the possible flaw distribution.

Set-up:

- Up to 1300 cells are possible
- Preset templates can be created
- Easy set-up by means of user guidance (wizard)

Evaluation:

- All measured values incl. A-scan are stored
- Evaluation of the matrix (min., max., mean value) is possible on the device
- All readings from the monitor gate plus A-scan can be indicated

TOFD (Time-of-Flight Diffraction Technique)

The evaluation of diffraction signals from the edges of the discontinuities permits determination of the flaw position and size.

Storing of A-scans:

- A-scans are stored with raw data

Further functions:

- Wizard to set-up TOFD scaling
- Assignment of colour gradation in the TOFD-scan is also possible after scanning
- Automatic scan stop or endless scan, also with encoders
- Break function (scan can be halted)

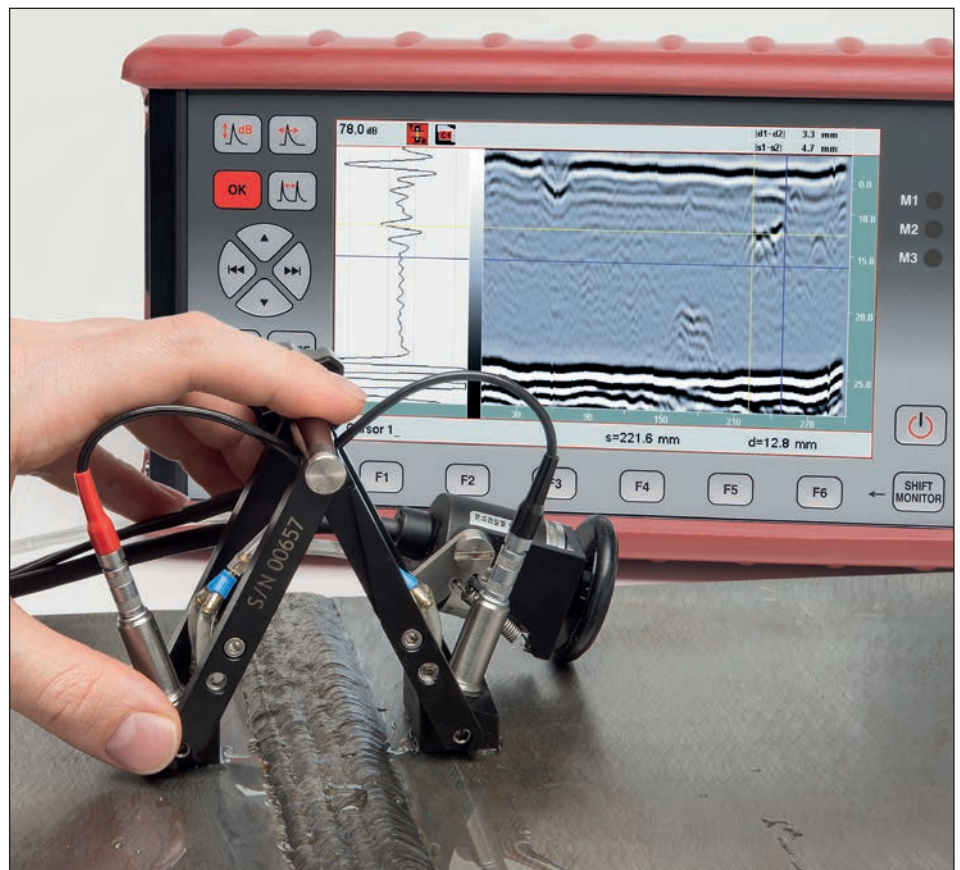

B-Scan Strip Chart

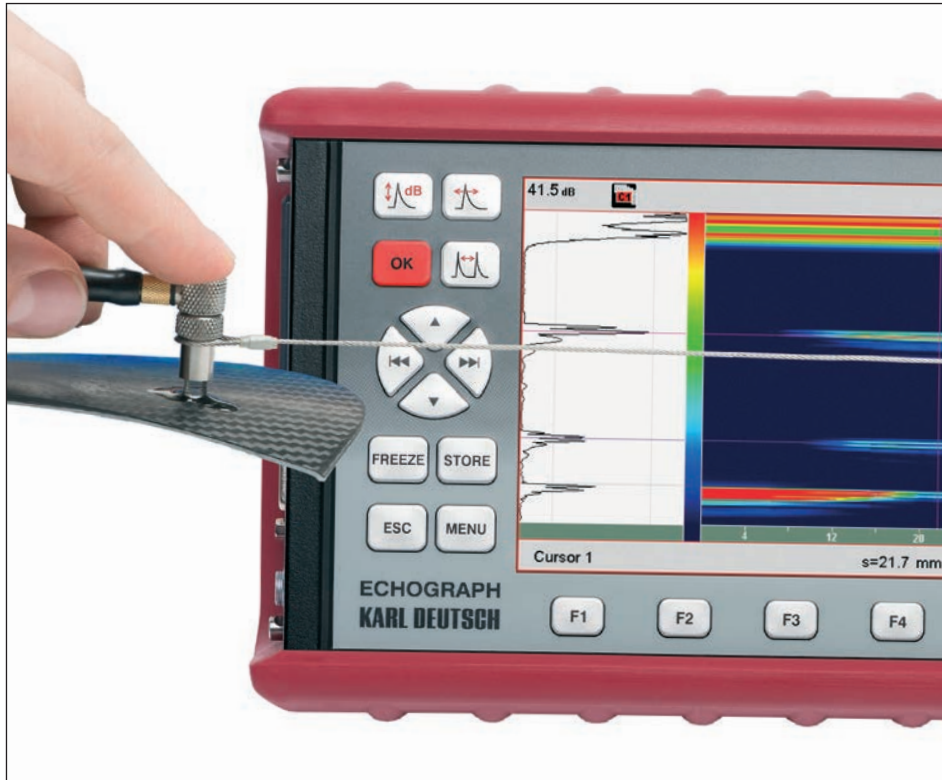

B-Scan

The B-scan provides more information: Rather than just recording a single reading from the monitor gate, the entire A-scan from each probe position is stored.

Small inclusions, changes in the material structure, near-surface or deep-located reflectors can be found and displayed more easily.

Strip Chart

The location is determined by means of a position encoder and transmitted digitally to the device.

Recording of measured values:

- For each probe position, the wall thickness, amplitude and sound path of all three monitor gates are stored
- An A-scan and up to two scans of readings can be shown simultaneously.
- All measured values can be stored

Advantages over a B-scan:

- Max. pulse repetition frequency of 5 kHz
- Strip chart can be used together with drop of back wall and TCG
- No restriction concerning the adjustment range



Operating the ECHOGRAPH 1095

The powerful ultrasonic flaw detector features 3 monitors for amplitude and time-of-flight measurement and 3 associated status lamps on the front panel for monitoring of threshold levels. The very compact instrument (54 mm case depth) provides fast digital ultrasonic electronics with a high sampling rate and pulse repetition frequencies up to 5000 Hz.

A convenient user guidance supports less-trained UT inspectors, also during probe handling and instrument adjustment: Simply activate the wizard and follow the instructions on the screen. Even difficult evaluation procedures for defect sizing (DAC/TCG, JIS, AWS and DGS) are carried out almost automatically.

The essential functions can be directly accessed via the foil keypad.

The 6 freely programmable function keys (F1 to F6) provide two different function levels. Switching between them is accomplished with the "SHIFT/MONITOR" button.

1st level:
6 freely programmable function keys, here, for instance, direct access to: rectification, transmitter damping, device configuration, time of flight, zoom

2nd level:
Adjustment of the three monitors (position, width, threshold)

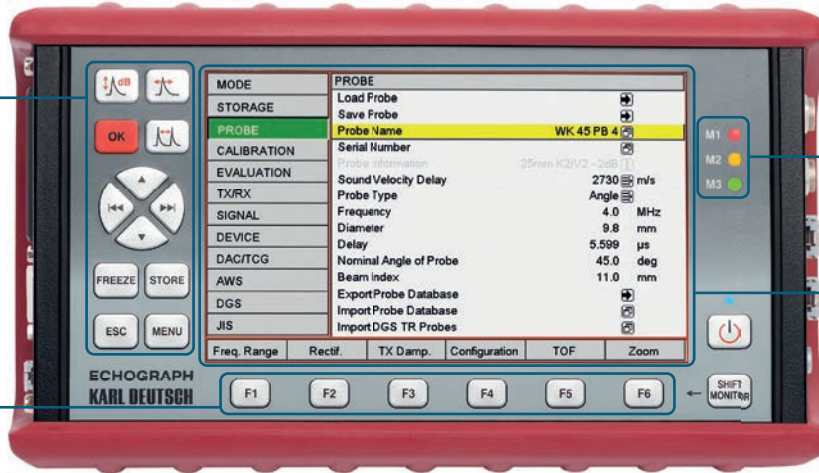

Separate visual indications for evaluation of the monitor thresholds (M1, M2, M3)

The high-resolution display is easy to read with a clearly arranged indication of parameters.

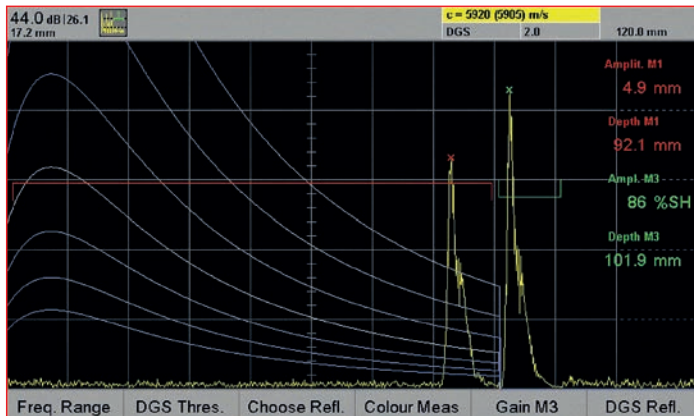

Echo evaluation DGS method (option):

- Not restricted to special probes (DGS curve is calculated within the instrument)
- Visualisation of the reference DGS curve
- Defect size (FBH = flat bottom hole) is directly shown
- DGS with KARL DEUTSCH TR probes
- Indication of up to 6 additional threshold curves

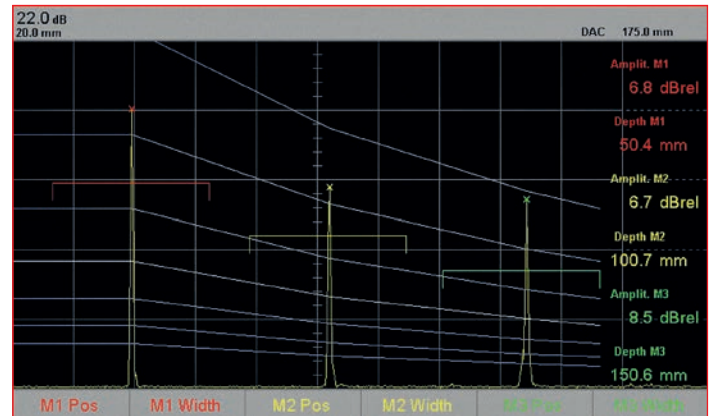

Echo evaluation DAC method (option):

Reference line method (EN 1330-4)

- Optical and acoustical alarm when exceeding or dropping below the curve
- Indication of up to 6 threshold curves
- DAC support points can be manually added, shifted and deleted (up to 16 points)
- Calculation of time corrected gain (TCG) from the DAC curve

Extensive Functions Application Examples

Time Corrected Gain (TCG)

Clearly visible icon indicates the currently active evaluation method.

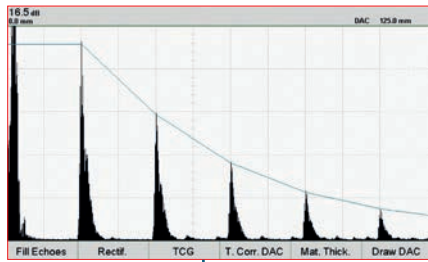

Recording of the DAC curve

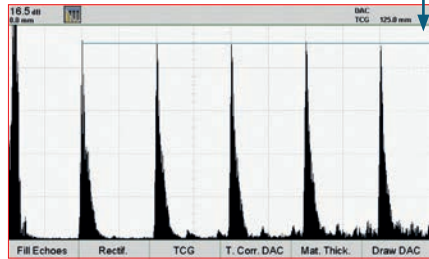

For TCG evaluation the gain is adjusted depth-dependent according to the previously recorded DAC curve.

Backwall echo attenuation via separate gain in monitor 3

Can be combined with many other functions, such as DGS, DAC and wall thickness measurement.

MODE	EVALUATION PARAMETERS	
STORAGE	Monitor 1	On
	Monitor 2	Off
PROBE	Monitor 3	On
CALIBRATION	Measurement Selection	On
EVALUATION	Gain M3	28.0 dB
TX/RX	Monitor 3	
SIGNAL	Evaluation Mode M3	%SH
DEVICE	M3 Statistical Clearing	0
	M3 Sound	Off
DAC/TCG	M3 Signal Mode	Normal
AWS	Back Drop	On

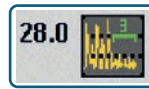

Clearly visible icon indicates the currently active evaluation method.

Gain of 28 dB inside monitor 3 and 45 dB outside

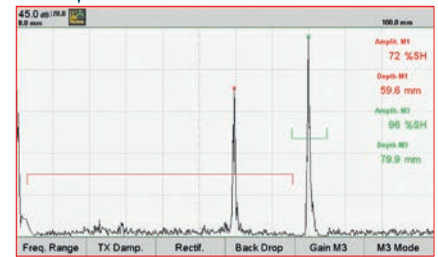

MODE	EVALUATION PARAMETERS	
STORAGE	Monitor 1	On
	Monitor 2	On
PROBE	Monitor 3	On
CALIBRATION	Measurement Selection	On
EVALUATION	Time of Flight	TOF
	Peak	0-Crossing
	Edge	0-Crossing
	0-Crossing	0-Crossing
TX/RX	Transmission Mode	Off
SIGNAL	Zoom	Off
DEVICE	WALL THICKNESS	
DAC/TCG	Averaging [M1-M2]	16
AWS		
DGS		
JIS		

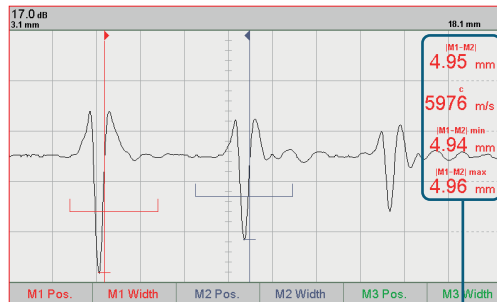

Wall thickness measurement

Precise wall thickness measurement between zero crossings with averaging and min/max storage (e.g. for corrosion mapping)

Current wall thickness: |M1 - M2|
Current sound velocity: c
Lowest wall thickness: |M1 - M2| min
Highest wall thickness: |M1 - M2| max

Adaption to curved surfaces

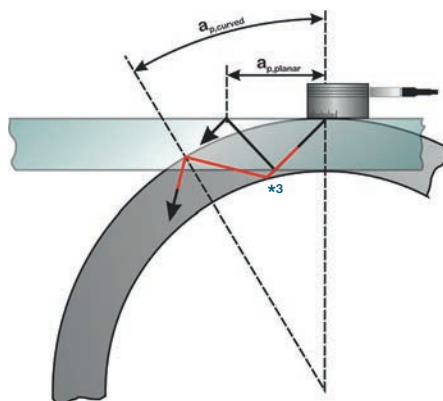

Calculation of defect depth and reduced projection distance considering the parameters of test object and probe.

Auto Adjustment	
Probe Name	WK 45 PB 4 (I)
Load Probe	
Measurement Selection	On
Sound Velocity	3255 m/s
Mode	Tube
Material Thickness	15.0 mm
Tube Diameter	250.0 mm
Next	

Monitor 1	
Evaluation Mode M1	%SH
M1 Statistical Clearing	0
M1 Sound	Off
M1 Signal Mode	Normal
Skip Marking M1	On
M2 follows M1	Off

Skip Marking M1	
Start M1	0.3 S(p)
Stop M1	1.3 S(p)

*1 automatic monitor positioning
*2 here: from 0.3 to 1.3 times the skip distance
*3 sound path marked in red



Clearly visible icon indicates the currently active evaluation method.

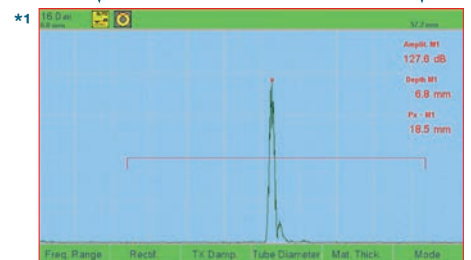
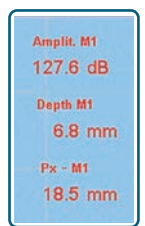

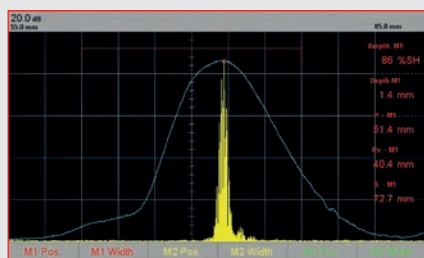

Envelope Curve:

For evaluation of the echo dynamics the envelope curve can be recorded.

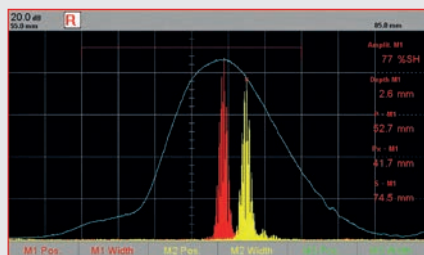

Reference Curve: Stored data can be used as reference curve. Thus, in case of repeated testing, the current result can be directly compared with the previous measurement.

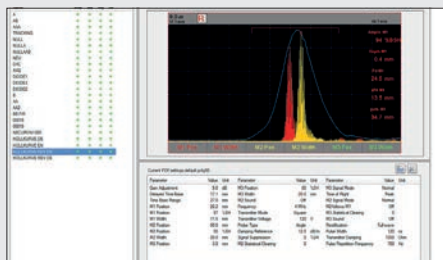

Data Storage:

All data records are stored on a removable 8 GB SD industrial flash card. Screenshots are saved as BMP files and measurement values as CSV files. Test reports can be easily created in a comfortable way with our eCom 95 software.

Overview of more features of the ECHOGRAPH 1095

- Rugged metal housing with rubber protective holster for rough environmental conditions
- Continuously adjustable stand with anti-slide coating
- Selectable screen colours for A-scan
- Antireflective protective glass
- USB interface
- Three optical indicators and an acoustical alarm output
- Energy saving mode in battery operation
- Built-in Li-ion-rechargeable battery (built-in charging processor); charging of the battery also during test if connected to the mains power supply
- Easily exchangeable battery
- Use of industrial SD flash cards up to 32 GB
- Update resp. upgrade via SD flash card and/or via unlock code
- Specifications acc. to EN ISO 22232-1

Screen

Screen type	<ul style="list-style-type: none"> ▪ Colour TFT LC display, transmissive ▪ LED background illumination (with automatic adaption to the ambient light)
Screen size	152.4 mm x 91.44 mm
Resolution	800 x 480 pixel, 256 colours
A-scan size	152 mm x 76.2 mm
Scaling	generated electronically
Scale division	<ul style="list-style-type: none"> ▪ coarse: 10-fold horizontal, 5-fold vertical ▪ fine: 25-fold horizontal

A-Scan Representation and Digitizing

Image refresh frequency	60 Hz
A-scan representation	<ul style="list-style-type: none"> ▪ normal display ▪ filled echoes ▪ frozen ▪ echo dynamics curve (envelope curve) ▪ zoom across monitor 1 and monitor 2 ▪ Option: Matrix Memory, B-Scan, Line Scan, TOFD ▪ Reference curve
RF representation	with zero crossing measurement
Rectification	full wave, positive, negative
Suppression	adjustable: 0 – 99 % screen height in 1 % steps (linear)
Zoom	monitor range (monitors 1 and 2)

Measuring Ranges

Time-base range	0.5 – 17760 mm steel
Sound velocity	200 – 15000 m/s in 1 m/s steps
Pulse shift	0 – 3000 mm in 0.1 mm steps
Linearity of time base	± 0.5 % of screen width
Pulse repetition frequency	10 – 5000 Hz, for square wave pulser up to 1000 Hz (automatic optimization [Auto High, Auto Low] or manual adjustment)
Trigger	internal, external, 1st echo

Transmitter

Transmitter type	square wave pulser
Transmission voltage	60 – 320 V
Pulse width	30 – 5000 ns in 10 ns steps
Transmitter damping	50, 75, 220, 1000 [Ω]

Receiver

Frequency ranges	LP 0.2 – 2 MHz, 2 MHz, 4 MHz, 5 MHz Broadband 1.3 – 14 MHz, 10 MHz HP 4.9 – 22 MHz, 0.8 – 8 MHz
Adjustable gain	110 dB in 0.1/1/2/6/12 dB steps

Technical Data (continued)

Echo Evaluation, Flaw Size Determination	
Display of echo height	<ul style="list-style-type: none"> ▪ % screen height (%SH) ▪ dBrel (DGS, DAC, TCG, JIS, AWS versions) ▪ dBabs ▪ indication rating acc. to AWS D1.1/1.1M ▪ region of echo height acc. to JIS Z3060-2002 ▪ mmFBH (DGS option)
Display of time of flight	<ul style="list-style-type: none"> ▪ sound path ▪ depth, projection distance and reduced projection distance ▪ sound transit time ▪ resolution 0.1 mm
Display of wall thickness / sound velocity	<ul style="list-style-type: none"> ▪ wall thickness measurement: 0.01 mm resolution (optional display of sound velocity to a given wall thickness) ▪ min/max wall thickness

Options	
AWS	AWS D1.1
DAC/TCG	max. 16 points, TCG 40 dB dynamic range
DGS	backwall, flat bottom hole or side drilled hole as reference
JIS	JIS Z3060
TOFD / B-Scan / Strip chart / Matrix memory	
Output module	for link-up to test automation

Monitor	
Number of monitors	3
Response time	with pulse repetition frequency (max. 5000 Hz)
Operation modes	normal, inverse, off
Setting range	<ul style="list-style-type: none"> ▪ monitor start: 0 – 20000 mm in 0.1 mm steps ▪ monitor width: 0 – 3000 mm in 0.1 mm steps
Positioning	<ul style="list-style-type: none"> ▪ independent manual adjustment ▪ coupling of monitor 1 and monitor 2 ▪ automatic positioning depending on the skip distance for angle beam probes
Visual indication	3 LED's on front panel
Acoustical indication	alarm sound

Storage	
SD flash card	8 GB industrial card (up to 32 GB usable)
Data format	CSV
Image format	BMP

Inputs and Outputs	
Probe connector	2 x LEMO 1
USB interface	LEMO-B, 4 pin (adapter cable with USB type A)
VGA output	standard VGA socket (15 pin D-Sub)
Trigger input/output	LEMO-1B, 10 pin: TTL level (5V), low active

Further Features	
Measuring units	switchable mm, inch
Date and time	built-in real-time clock
Languages	English, German, further languages on request
Permissible temperatures: Operation (with batteries/storage temperature)	-10 °C to +50 °C / -20 °C to +60 °C

Power Supply	
Mains operation	via mains power supply (article no. 1808.503) <ul style="list-style-type: none"> ▪ 100 - 240 VAC, 50 - 60 Hz ▪ output: 12 VDC, 4 A ▪ permissible operating temperature: 0 °C to +50 °C
Battery operation	approx. 9.5 hrs (with factory settings) with built-in Li-ion rechargeable battery
Power saving mode	on / off
Automatic switch-off	in case of low voltage of mains or battery

Dimensions and Weight	
Dimensions (H x W x D)	<ul style="list-style-type: none"> ▪ 138 mm x 249 mm x 52 mm without protective holster ▪ 149 mm x 262 mm x 54 mm with protective holster
Weight	2.0 kg (with Li-ion battery and protective holster)

KARL DEUTSCH Pruef- und Messgeraetebau GmbH + Co KG
 Otto-Hausmann-Ring 101 · 42115 Wuppertal · Germany
 Phone +49 202 7192 0 · Fax +49 202 7192 123
 info@karldeutsch.de · www.karldeutsch.de

DIN EN ISO
9001
certified

KARL DEUTSCH